





roots



authentic



reflection

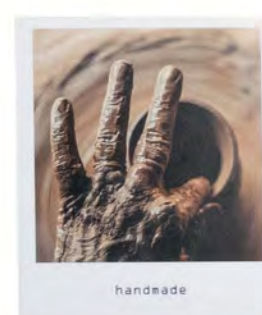

handmade



earth



simplicity



natural

ROOTS

Roots is our vision of the Terracota.

Organic looking pieces of Art inspired in nature and the authenticity of the impact of time given by the character of aging graciously.

Given its innovative dual finish of smooth touch and outstanding resistance coexisting, it can be used anywhere and particularly outdoors.

Honest and meaningful designs, for a distinctive way of thinking.

Roots es nuestra visión de la Terracota.

Piezas de Arte de caracter orgánico inspiradas en la naturaleza y la autenticidad marcada por el paso del tiempo y su huella.

Dado su innovador acabado dual de tacto suave y durabilidad extrema coexistiendo, se puede utilizar en cualquier espacio y particularmente en exterior.

Integridad en el diseño para una forma de pensar distinta.



NO LIMITS!

This collection has been created using a specially formulated matt enamel for use both indoors and outdoors.

Thanks to an innovative **non-slip surface R11 / Class 3 / DCOF > 0.42**, Roots can be installed in wet areas. However, its soft-touch finish makes it suitable for interior use, allowing for aesthetically uniform spaces.

One product, unlimited uses.

Esta colección ha sido creada utilizando un esmalte mate especialmente formulado para su uso tanto en interior como en exterior.

Gracias a una innovadora superficie **antideslizante R11 / Clase 3 / DCOF > 0,42**, Roots puede instalarse en zonas húmedas. Sin embargo, su acabado suave al tacto lo hace adecuado para su uso en el interior, lo que permite conseguir espacios estéticamente uniformes.

Un sólo producto, usos ilimitados.



Roots S Sand
Roots M Sand

01. SIZES, COLOURS AND FINISHES / FORMATOS, COLORES Y ACABADOS	<i>pag. 10</i>
02. GET INSPIRED / INSPIRATE	<i>pag. 12</i>
03. LAYOUTS / COLOCACIONES	<i>pag. 38</i>
04. RECOMMENDATIONS / RECOMENDACIONES	<i>pag. 44</i>
05. TECHNICAL FEATURES / CARACTERÍSTICAS TÉCNICAS	<i>pag. 45</i>
06. TECHNICAL DRAWINGS / DIBUJOS TÉCNICOS	<i>pag. 46</i>
07. PACKING	<i>pag. 47</i>
08. PRICE CODE / CÒDICO DE TARIFA	<i>pag. 47</i>



ROOTS L 22x22 cm / 8.6"x8.6"

\$ W23 P



Sand



Cotto



Rust

ROOTS M 11x22 cm / 4.3"x8.6"

\$ W23 P



Sand



Cotto



Rust

ROOTS S 11x11 cm / 4.3"x4.3"

\$ W23 P



Sand



Cotto



Rust

ROOTS S 11x11 cm / 4.3"x4.3"

\$ W36 P



White Gloss



Turques Gloss



Olive Gloss



Teal Gloss



Indigo Gloss



Honey Gloss



Roots M Sand
Roots S Sand
Roots S White Gloss



Roots L Rust - 80%
Roots S Teal Gloss -20%



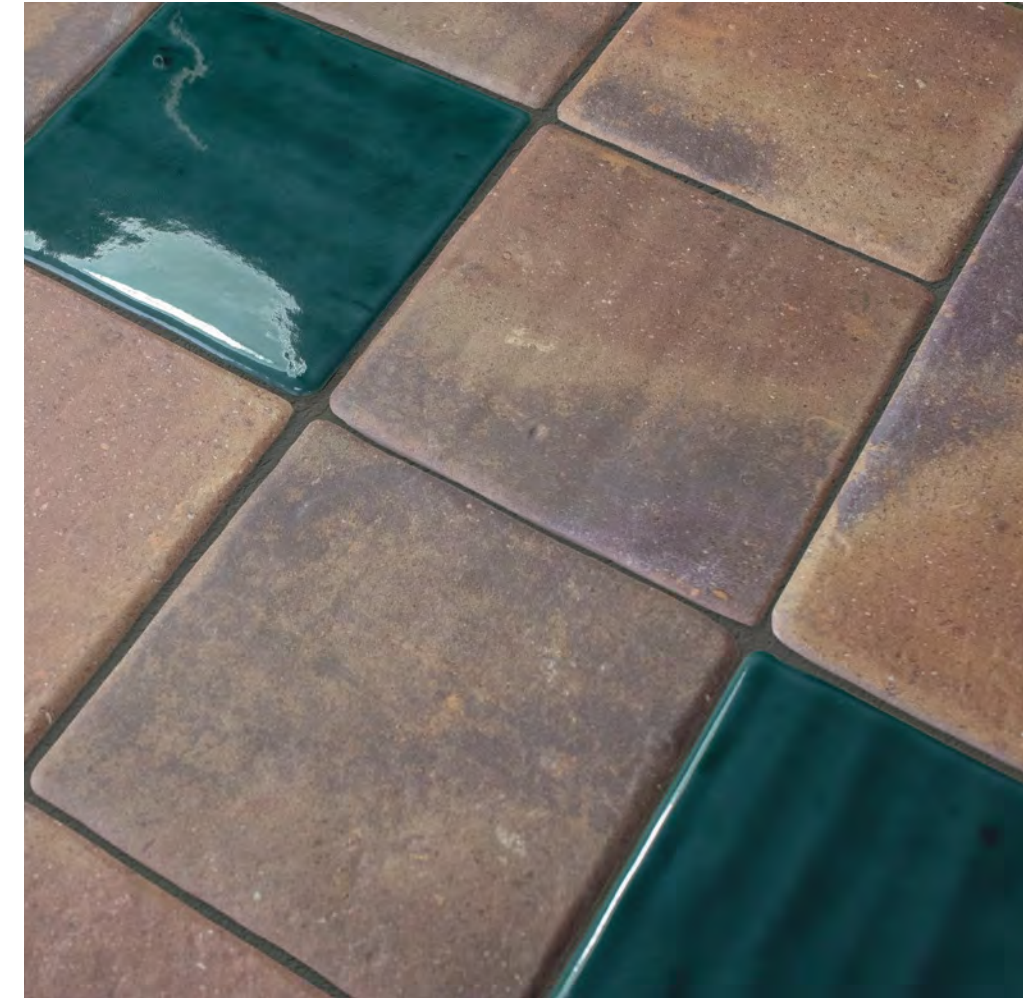

Roots S Rust
Roots S Teal Gloss

Roots L Rust
Roots M Rust
Roots S Teal Gloss

◀ **Zellige White Matt**



Roots S Sand
Roots S Honey Gloss





Roots S Cotto - 50%
 Roots S White Gloss - 50%



Roots S Cotto - 50 %
Roots S Sand - 50 %



Roots L Sand - 66,6 %
Roots M Sand - 33,3 %
Roots S White Gloss ▶



Roots L Rust - 44,4%
Roots M Rust - 44,4%
Roots S Rust - 11,2%



Roots L Sand
Roots S Olive Gloss
Roots S Sand





Roots L Cotto
Roots S Cotto
Roots S Turquoise



Roots L Rust
Roots M Rust





Roots L, M & S Sand
Roots S Teal Gloss
Roots S Honey Gloss
Roots S White Gloss

Randomly Installed

Roots M Sand - 50 %
Roots M Rust - 50 %



Roots L Cotto
Roots M Cotto
Roots S Indigo Gloss





Roots L Sand
Roots S Sand
Roots S Turques Gloss

UNLIMITED
COMPOSITIONS

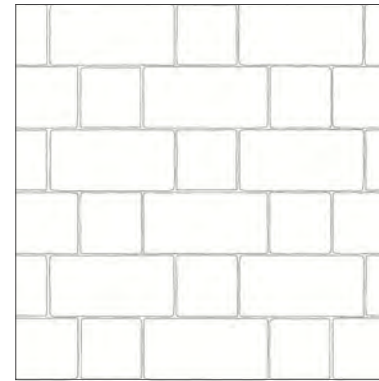

Roots M - 66,7%
Roots S - 33,3%

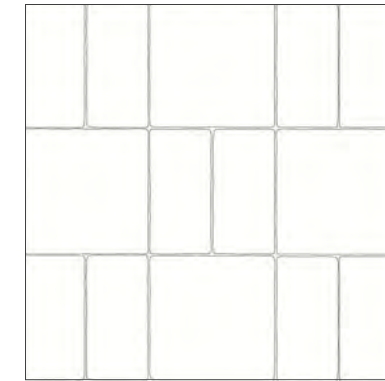

Roots L - 50%
Roots M - 50%

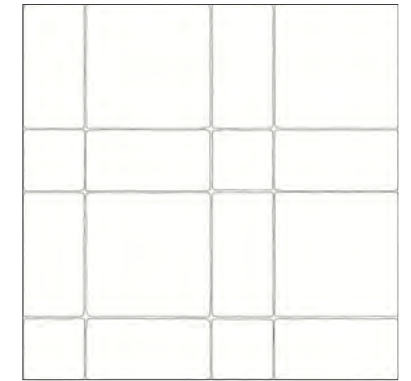

Roots L - 50%
Roots M - 33,3%
Roots S - 16,7%

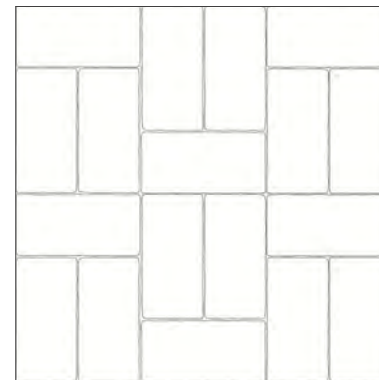

Roots M - 100%

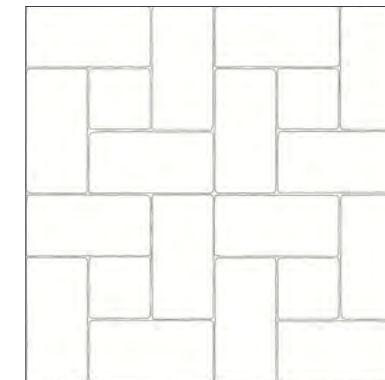

Roots M - 88,9%
Roots S - 11,1%

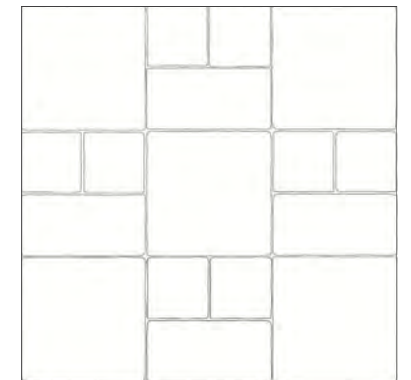

Roots L - 50%
Roots M - 25%
Roots S - 25%

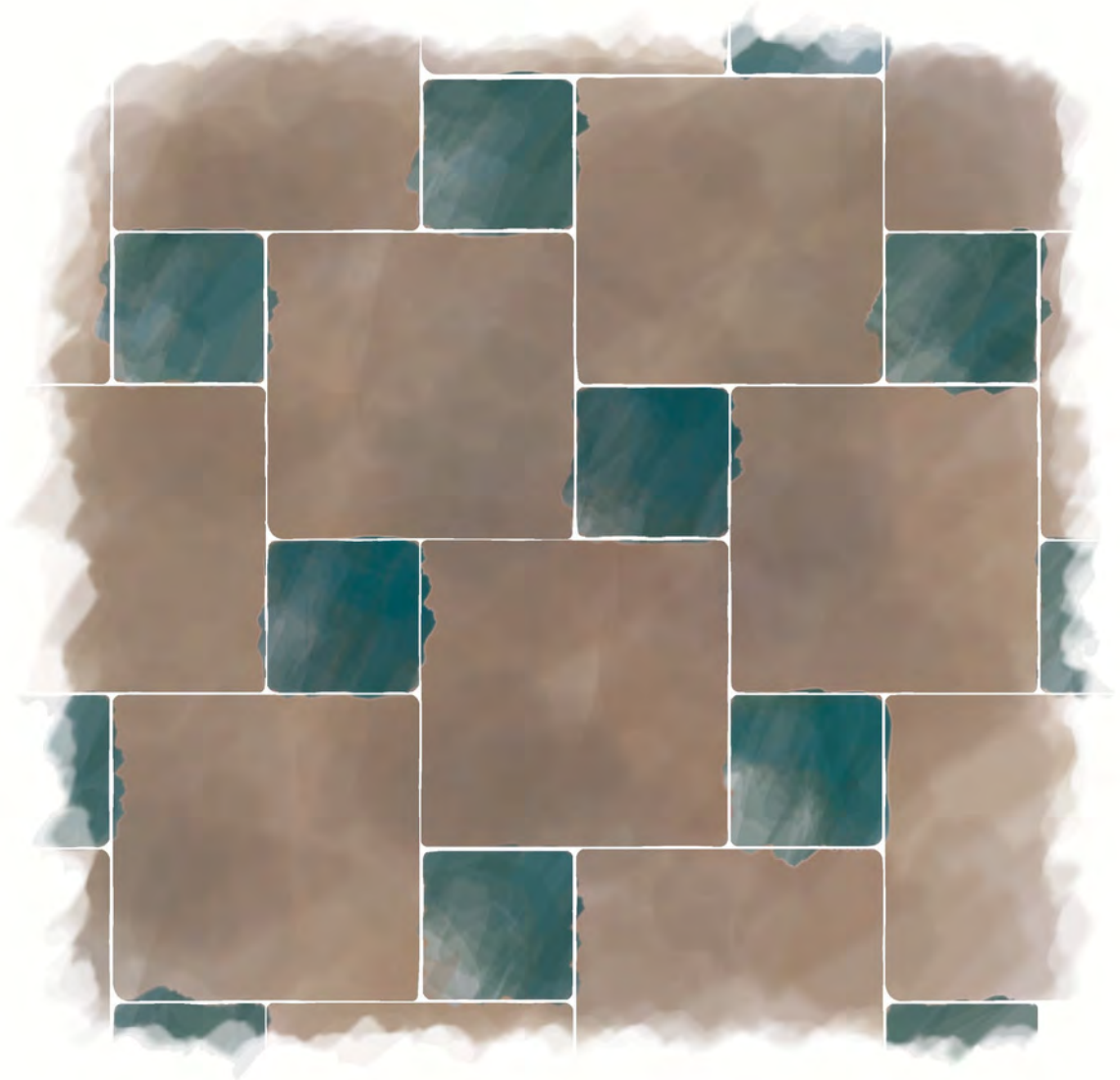

Roots L Rust - 80%
Roots S Indigo - 20%

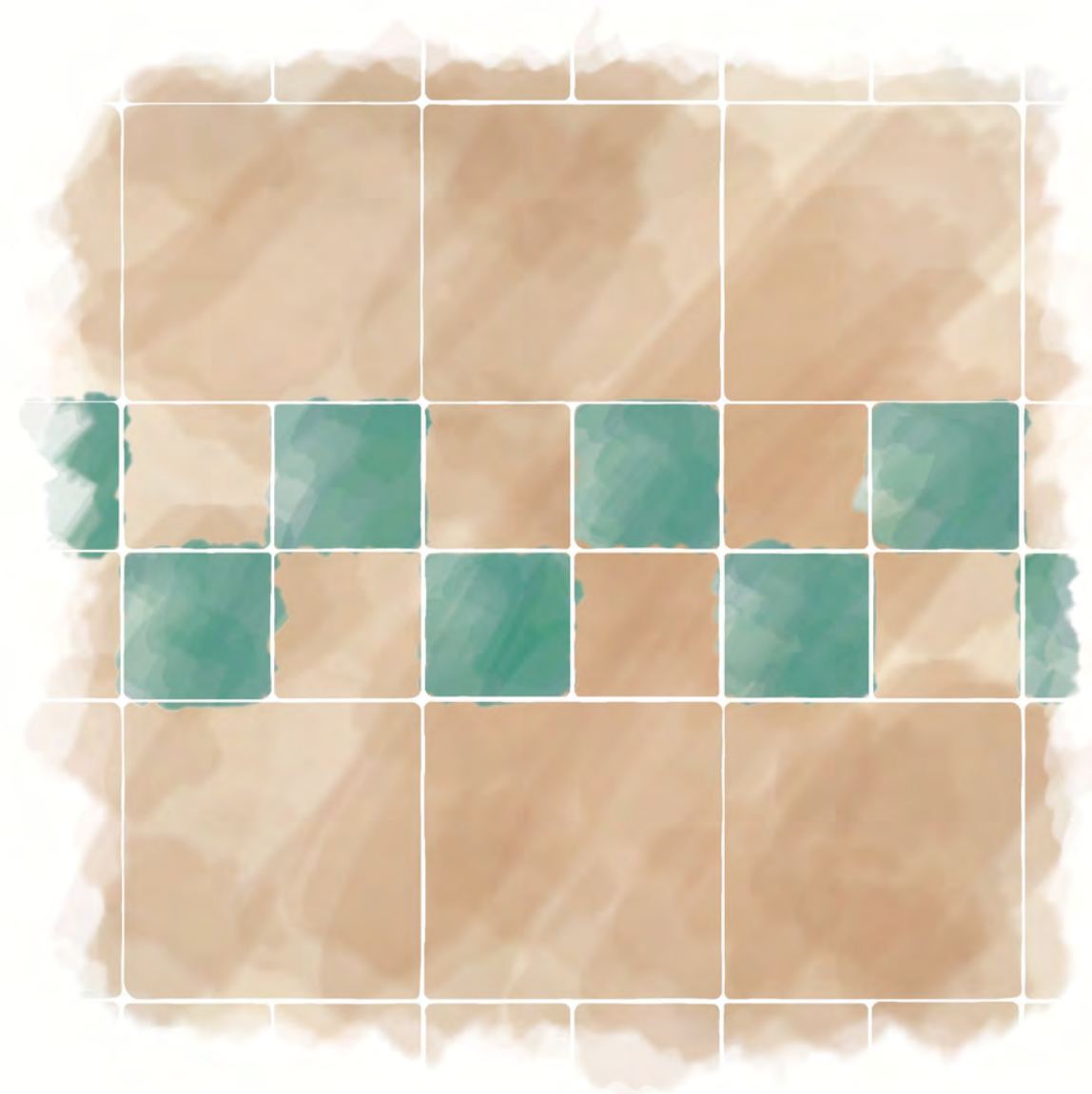

Roots L Sand - 50%
Roots S Sand - 25%
Roots S Turques Gloss - 25%



Roots S Cotto - 50%
Roots S White Gloss - 50%

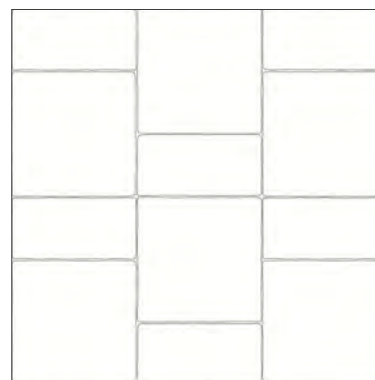

Roots L - 66,7%
Roots M - 33,3%

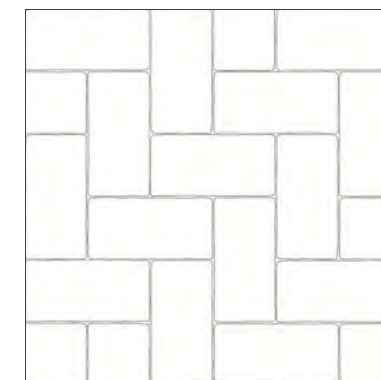

Roots M - 100%

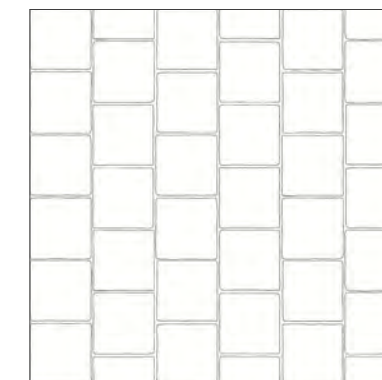

Roots S - 100%

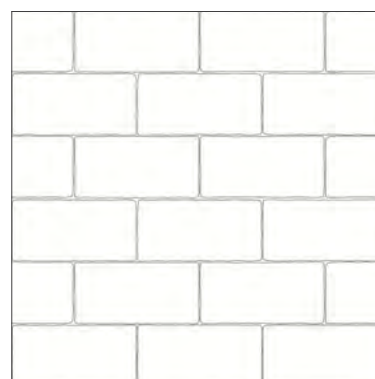

Roots M - 100%

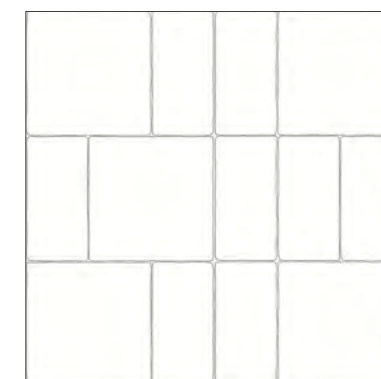

Roots L - 50%
Roots M - 50%

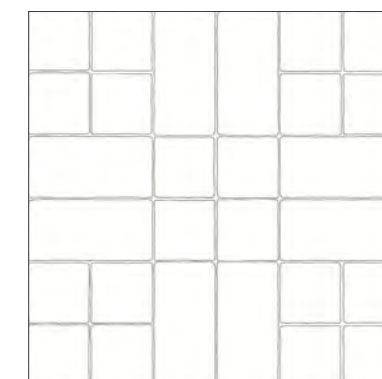

Roots M - 50%
Roots S - 50%

ALMACENAMIENTO

Para garantizar las características de su acabado, el producto debe mantenerse en su embalaje original hasta el momento de la colocación. Si el producto va a permanecer almacenado durante un largo periodo es conveniente hacerlo bajo cubierta.

COLOCACIÓN

Para garantizar una buena adhesión al soporte es necesaria la utilización de materiales de agarre y de rejuntado adecuados al ambiente al que vayan a estar sometidos. La colocación con morteros tradicionales no garantiza una buena adhesión.

Debido a la naturaleza del material pueden existir diferencias dimensionales entre piezas. Por ello deberán planificarse y ejecutarse correctamente todo tipo de juntas: estructurales, perimetrales, de dilatación y de colocación. La colocación sin juntas es desaconsejable desde cualquier punto de vista técnico, pudiendo ser el origen de diversas patologías. Para un resultado óptimo recomendamos usar 2 mm de junta.

MANTENIMIENTO Y LIMPIEZA

Finalizada la puesta en obra se recomienda eliminar los restos de materiales de agarre y rejuntado con un desincrustante comercial diseñado expresamente para baldosas cerámicas, rebajado con agua, permaneciendo en contacto con la superficie a limpiar no más de 5 minutos. Como norma general no deben utilizarse detergentes en polvo ni estropajos metálicos o abrasivos. Generalmente será suficiente con una esponja, agua tibia y un jabón líquido neutro. Posteriormente aclarar con abundante agua limpia.

VARIACIÓN CROMÁTICA

La colección Roots ha sido diseñada con una alta variación de tono entre piezas. Es importante verificar el producto antes de su instalación puesto que ninguna reclamación será aceptada una vez instalado.

¡ATENCIÓN!

Esta colección reproduce azulejos tradicionales hechos a mano, por esta razón existen ligeras diferencias dimensionales entre piezas (largos y anchos variables), que forman parte de la estética final que se busca. Es recomendable la instalación ajustando a mano cada una de las piezas debido a las diferencias dimensionales en vez de utilizar separadores. Estas diferencias son las que aportan su carácter, aspecto artesano y un resultado final de alto valor estético.

WAREHOUSING

In order to guarantee the characteristics of the finish the product must be kept in its original packaging until the time of fixing. If the product is likely to be stored for a long period of time it should be suitably covered.

TILE FIXING

To ensure the products adhere correctly to the surface, it is essential to use specific adhesive and grouting material. This must also be suitable for the environment they will have to withstand. Fitting with traditional mortars does not ensure good adhesion.

Due to the nature of the material there may be dimensional variations between pieces. Therefore, all types of joints must be planned and carried out correctly: structural, perimeter, expansion and installation joints. Fitting tiles without joints is not advisable from any technical point of view as this may lead to various problems. For an optimal result we advise to use 2 mm (0.08") grout.

MAINTENANCE AND CLEANING

Once the materials have been fitted, it is advisable to remove any remaining adhesive and grouting material by using a commercial descaling product designed especially, diluted with water. The descaling product must not remain in contact with the surface to be cleaned for more than 5 minutes. As a general guideline, powder detergents should not be used, not wire wool or abrasive materials. Generally a sponge will be sufficient with warm water and liquid neutral soap. Then rinse with plenty of clean water.













CHROMATIC VARIATION

Roots Collection has been designed with a high chromatic variation between pieces. Prior to any installation, range of tiles should be checked by the client. No claims will be accepted after installation.

WARNING!

This collection reproduces traditional hand made tiles, this is the reason why there are slight dimensional differences between pieces (variable lengths and widths), which are part of the intended aesthetic. It is advised to adjust each one of the pieces in the process of installation due to the dimensional differences, instead of using spacers. As a result, these differences give the character, craftsman feel and a high aesthetic value.

Dry-pressed porcelain tiles with water absorption B la ≤ 0,5% for interior and exterior floors and walls.
Baldosas cerámicas prensadas en seco con absorción de agua B la ≤ 0,5% para suelos y paredes interiores y exteriores.

FEATURES / CARACTERÍSTICAS	SPECIFICATION / ESPECIFICACIÓN	NORMA
 Dimensional Features	110 mm +/- 0,9 mm x 110 mm +/- 0,9 mm x 10 mm +/- 5% 110 mm +/- 0,9 mm x 220 mm +/- 0,6% x 10 mm +/- 5% 220 mm +/- 0,6% x 220 mm +/- 0,6% x 10 mm +/- 5%	UNE-EN ISO 10545-2:1998
 Water absorption	E b ≤ 0,5%	UNE-EN ISO 10545-3:1997
 Modulus of rupture	Minimum 35 N/mm2 Individual Minimum 32 N/mm2	UNE-EN ISO 10545-4:2012
 Abrasive resistance	PEI 5: White Gloss PEI 3: Sand, Cotto PEI 2: Rust, Turques Gloss, Olive Gloss, Teal Gloss, Indigo Gloss, Honey Gloss	UNE-EN ISO 10545-7:1999
 Crazing resistance	Pass	UNE-EN ISO 10545-11:1997
 Frost resistance	Pass	UNE-EN ISO 10545-11:1997
 Household products resistance	GA	UNE-EN ISO 10545-13:1998
 Chemical resistance	GHA	UNE-EN ISO 10545-13:1998
 Stain resistance	5	UNE-EN ISO 10545-14:1998
 Non-slip value	R11 / CLASS 3 / DCOF >0,42 (EXCEPT GLOSS)	DIN 51130:2014 ANSI A137.1:2012
 Tone variation	V5	-
 Porcelain body	-	-

ROOTS L

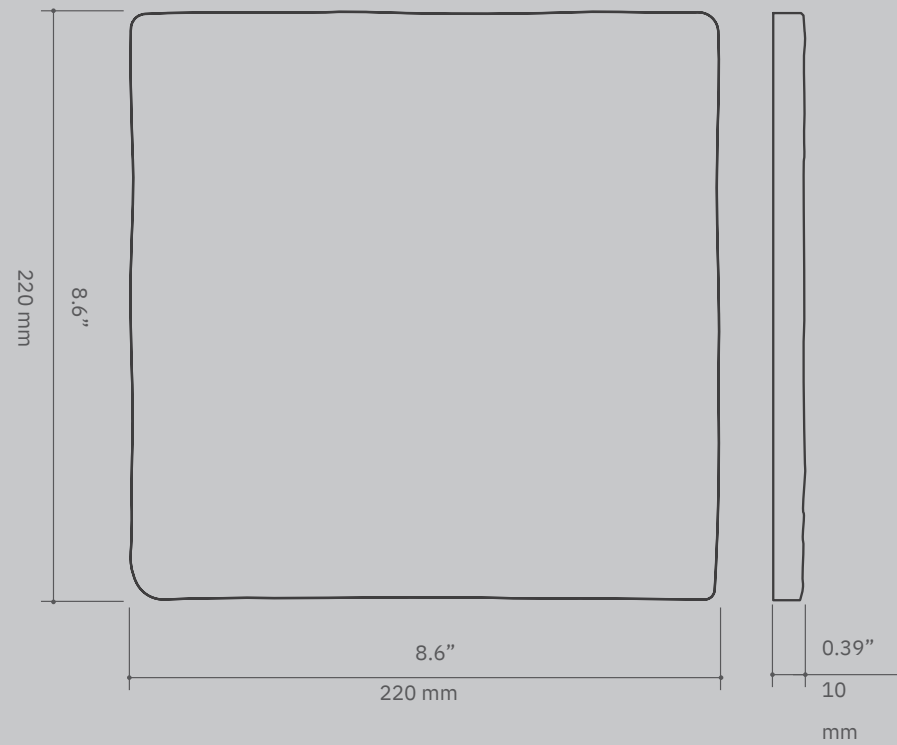

ROOTS M

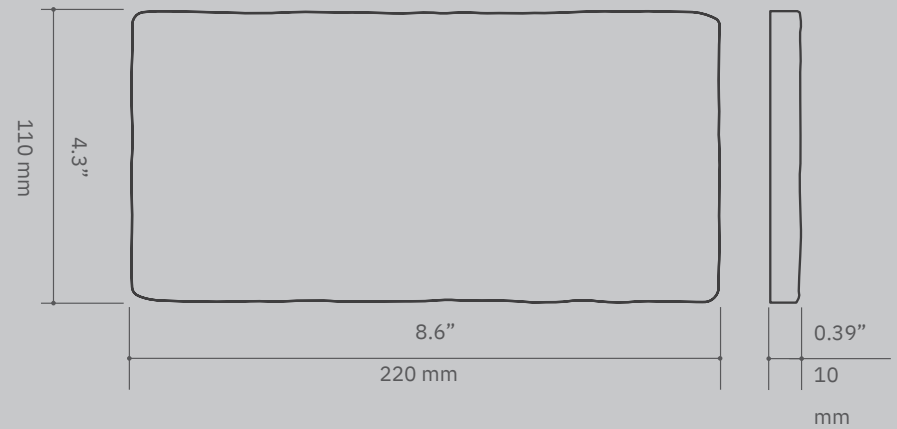

ROOTS S

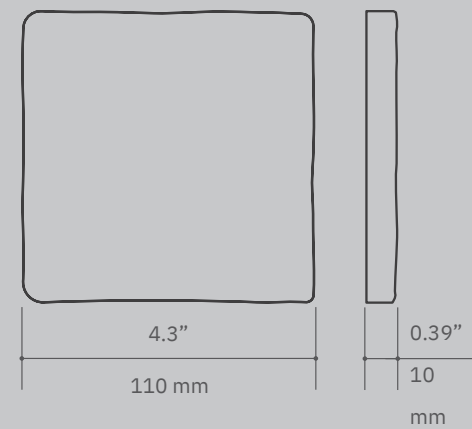

Model	Size (in)	Pieces/box	lb/box	sq ft/box	Box/pallet	sq ft/pallet
Roots S	4.3"x4.3"	30	17.73 lb	3.907 sq	125	488.375 sq
Roots M	8.6"x4.3"	30	34.97 lb	ft 7.815	50	ft 390.750
Roots L	8.6"x8.6"	15	35,60 lb	sq ft	50	sq ft
				7.815 sq		390.750 sq
				ft		ft

Modelo Model	Tamaño (cm) Size (cm)	Piezas/caja Pieces/box	Kg/caja kg/box	m2/caja m2/box	Cajas/pale t Box/pallet	m2/palet m2/pallet
Roots S	11x11 cm	30	8,04 kg	0,363	125	45,375
Roots M	11x22 cm	30	15,86 kg	m2	50	m2
Roots L	22x22 cm	15	16,15 kg	0,726	50	36,300
				m2		m2
				0,726		36,300
				m2		m2

08. PRICE CODE / CÒDICO DE TARIFA

W23	W36
Roots S, M & L Sand, Cotto & Rust	Roots S White, Turques, Olive, Teal, Indigo & Honey Gloss

Brought to you by

EST 1967

FACINGS

OF AMERICA

Designed by

WOW